

Clarion

TUNER/5-INCH COLOR LC DISPLAY WITH CD CHANGER/
DSP/EQ CONTROL

VRX8271

Owner's Guide & Installation

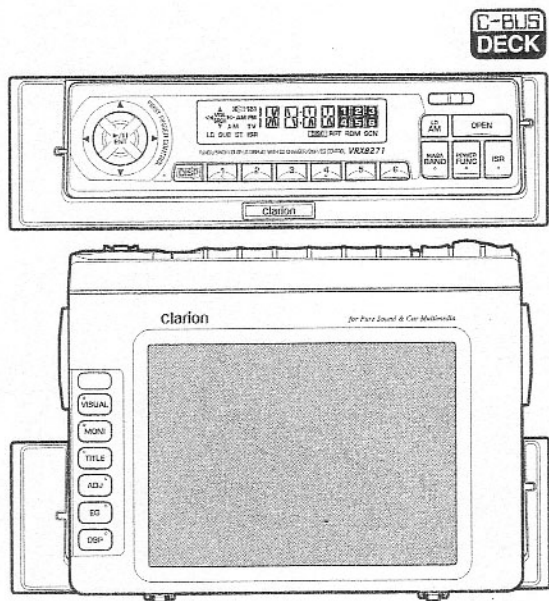

Thank you for purchasing the Clarion VRX8271.

- * Please read this Owner's Guide & Installation in its entirety before proceeding with wire connection and installation.
- * After reading this manual, be sure to keep it in a handy place (e.g., glove compartment).
If you sell the motor vehicle, please leave the manual in it so that the new owner can use it.
- * Read the contents of the enclosed warranty card and keep it with this manual.
- * The section "CD Changer Mode Operations" of this Owner's Guide provides the operation procedure of a CD changer which is connected to VRX8271 by C-BUS cable. (If you buy the CD changer only, it is accompanied only by its owner's guide. The operation guide of the CD changer is included in this Owner's Guide.)

■ Contents

English

| | |
|--|----|
| 1. PRECAUTIONS | 4 |
| 2. CONTROLS | 5 |
| 3. FEATURES | 6 |
| 4. MODE DISPLAY | 7 |
| 5. HANDLING COMPACT DISCS | 8 |
| 6. BUTTON TERMINOLOGY | 9 |
| First Finger Control Operation | 9 |
| 7. CAUTIONS ON HANDLING | 10 |
| Cleaning | 11 |
| 8. OPERATION | 12 |
| Basic Operations | 12 |
| Radio Mode Operations | 16 |
| CD Changer Mode Operations | 19 |
| Rear Vision Camera | 21 |
| Other Functions | 23 |
| Operating the DSP and Equalizer | 26 |
| 9. TROUBLESHOOTING | 32 |
| 10. ERROR DISPLAYS | 34 |
| 11. SPECIFICATIONS | 35 |
| • Installation/Wire Connection Guide | 37 |

1. PRECAUTIONS

1. This set is exclusively for use in motor vehicles with a 12V power supply, negative ground.
2. Do not operate the set in ways other than those described in this owner's guide. In addition, the LCD panel's opening/ closing mechanism is delicate, so do not operate or use it with excessive force.
3. When the inside of the motor vehicle is very cold and the player is used soon after switching on the heater, moisture may form on the disc or the optical parts of the player and proper playback may not be possible. If moisture forms on the disc, wipe it off with a soft cloth. If moisture forms on the optical parts of the player, do not use the player for about one hour and the condensation will disappear naturally to allow normal operation.
4. Driving on extremely bumpy roads which cause severe vibration may cause the sound to skip.
5. This unit uses a precision mechanism. Even in the event that trouble arises, never open the case, disassemble the unit, or lubricate the rotating parts.

⚠ CAUTION

USE OF CONTROLS, ADJUSTMENTS, OR PERFORMANCE OF PROCEDURES OTHER THAN THOSE SPECIFIED HEREIN, MAY RESULT IN HAZARDOUS RADIATION EXPOSURE. THE COMPACT DISC PLAYER SHOULD NOT BE ADJUSTED OR REPAIRED BY ANYONE EXCEPT PROPERLY QUALIFIED SERVICE PERSONNEL.

⚠ WARNING

THIS PRODUCT IS NOT INTENDED FOR VIEWING TELEVISION BROADCASTS OR VIDEO TAPES OR FOR PLAYING VIDEO GAMES. Such uses of this product may distract the driver or interfere with the driver's safe operation of the motor vehicle and may violate state law. CLARION DISCLAIMS ANY LIABILITY FOR ANY BODILY INJURY, INCLUDING FATALITIES, OR PROPERTY DAMAGE THAT MAY RESULT FROM ANY SUCH UNINTENDED USES OR FROM ANY IMPROPER USE OF THIS PRODUCT.

INFORMATION FOR USERS:

CHANGES OR MODIFICATIONS TO THIS PRODUCT WILL VOID THE WARRANTY AND WILL VIOLATE FCC APPROVAL.

2. CONTROLS / COMMANDES / CONTROLES

Note: Be sure to spread this page and refer to the front diagrams when you read each chapter.

SOURCE UNIT

When the display is closed

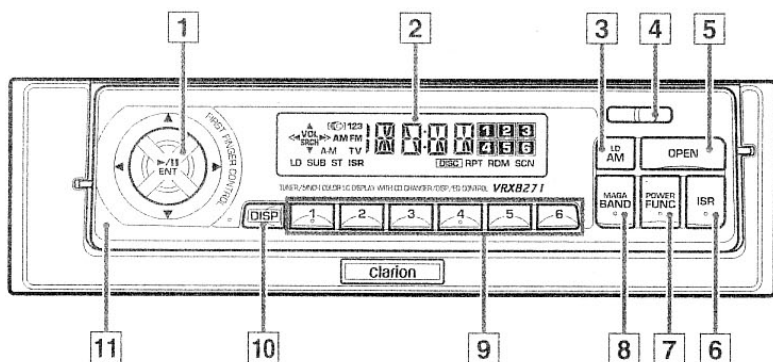

When the display is open

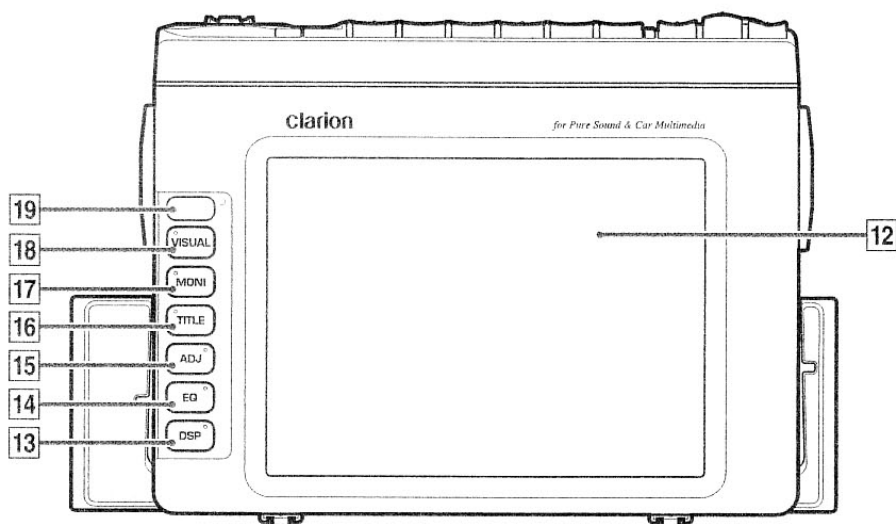

3. FEATURES

- 5-inch TFT Active Matrix Drive Type Color LCD Panel
- Shell Loading Mechanism
- Various Character Panels for AM/FM Reception, CD Display*, and Equalizer*, etc.
- Title memory function storing CD titles and AM/FM stations
- Environment setting function to select illumination color (amber/green), background color, and whether to turn on or off the beep sound
- Auto Store Function
- Multiple CD Changer Control
- RCA Gold-plated LINE OUT
- DCP function enables you to detach the operation panel to prevent theft

* Available when the CD changer or equalizer (sold separately) is connected

4. MODE DISPLAY

<Radio Mode Display>

Display

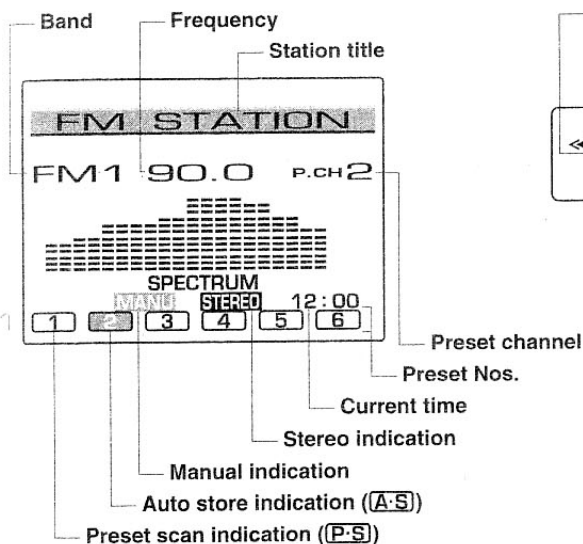

Information Panel

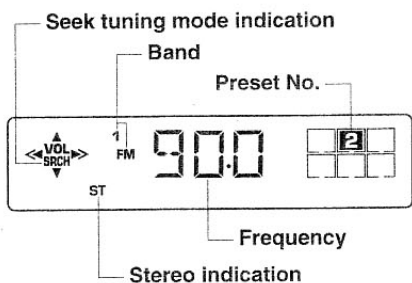

<CD Changer Mode Display>

Display

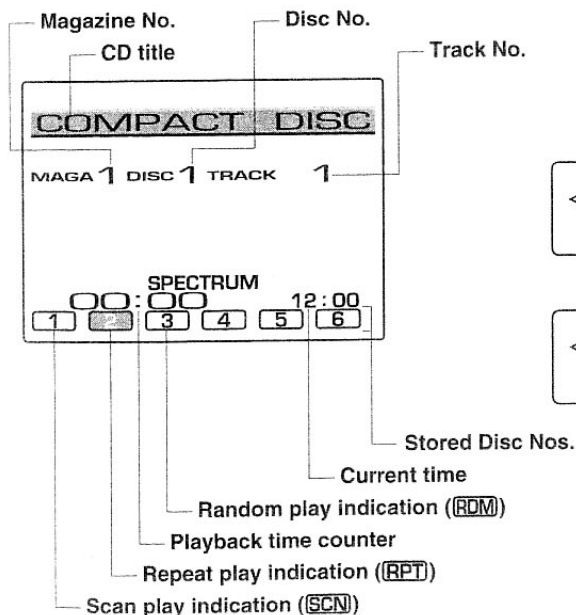

Information Panel

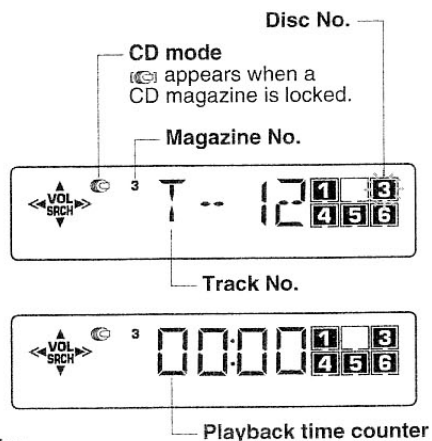

5. HANDLING COMPACT DISCS

This unit has been designed specifically for playback of compact discs bearing the  mark. No other discs can be played.

To remove the compact disc from its storage case, press down on the center of the case and lift the disc out, holding it carefully by the edges.

Removing the disc

Proper way to hold the compact disc

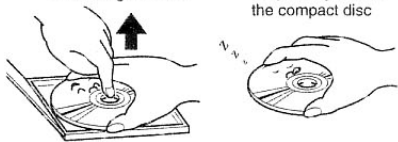

Always handle the compact disc by the edges. Never touch the surface.

To remove fingermarks and dust, use a soft cloth, and wipe in a straight line from the center of the compact disc to the circumference.

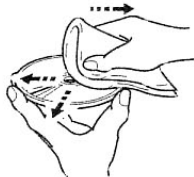

New discs may have some roughness around the edges. The unit may not work or the sound may skip if such discs are used. Use a ball-point pen, etc. to remove roughness from the edge of the disc.

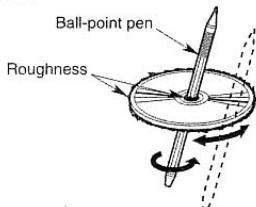

Note:

Do not use commercially available CD protection sheets or discs equipped with stabilizers, etc. These may get caught in the internal mechanism and damage the disc.

Note on Compact Discs

Never stick labels on the surface of the compact disc or mark the surface with a pencil or pen.

No

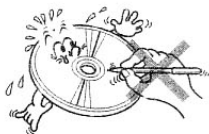

Do not use any solvents such as commercially available cleaners, anti-static spray, or thinner to clean compact discs.

No



Do not use compact discs that have large scratches, are misshapen, or cracked, etc. Use of such discs will cause misoperation or damage.

No



Do not expose compact discs to direct sunlight or any heat source.





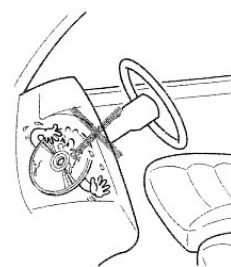



No



6. BUTTON TERMINOLOGY

Note: Be sure to read this chapter referring to the front diagrams of chapter "2. CONTROLS" on page 5 (spread).

- 1 Up/Down (▲ (Up)/▼ (Down), ◀ (Left)/▶ (Right)) Buttons
ENT (Enter ▶/II) Button
 - 2 **Information Panel**
 - 3 AM (Audio Mode) Button
LD (Loudness) Button
 - 4 DCP (Detachable Control Panel) Lever
 - 5 OPEN Button
 - 6 ISR (Instant Station Recall) Button []
 - 7 POWER Button
FUNC (Function) Button
 - 8 BAND Button []
MAGA (Magazine) Button []
 - 9 Preset Buttons []
Disc No. Buttons []
 - 10 DISP (Display) Button
 - 11 **Operation Panel**
 - 12 **Display**
 - 13 DSP (Digital Sound Processor) Button
 - 14 EQ (Equalizer) Button
 - 15 ADJ (Adjust) Button
 - 16 TITLE Button
 - 17 MONI (Monitor) Button
 - 18 VISUAL Button (Rear Vision Camera Indicator)
 - 19 Receiver for remote control unit
- [] : In Radio Mode
[] : In CD Changer Mode

First Finger Control Operation

By sliding the Up/Down button 1 up ▲, down ▼, right ▶, or left ◀, you can select various items and make settings. This function is called the First Finger Control Operation. With this function, you can select a menu or track, control the volume, or change a frequency according to the operation mode.

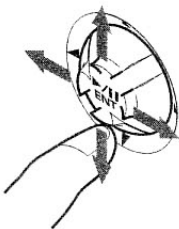

Press the center of the ENT button (▶/II) 1 to execute a selected menu, play/pause, or mute on/off.

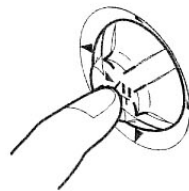

7. CAUTIONS ON HANDLING

For a longer service life, be sure to read the following cautions.

- Be sure to store the LCD panel inside the source unit when parking the car outdoors for long periods of time.

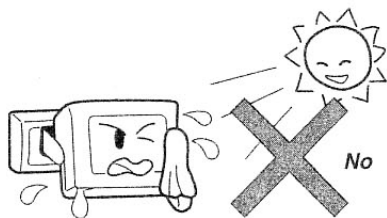

The LCD panel will operate properly in a temperature range of 32°F (0°C) to 140°F (60°C).

- Don't allow any liquids on the set from drinks, umbrellas etc. Doing so may damage the internal circuitry.

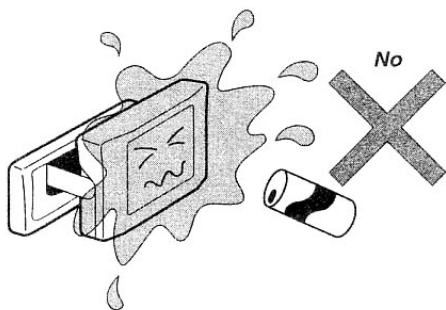

- Do not disassemble or modify the set in any way. Doing so may result in damage.

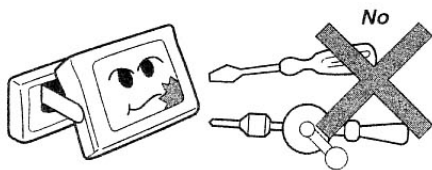

⚠ WARNING

THIS PRODUCT IS NOT INTENDED FOR VIEWING TELEVISION BROADCASTS OR VIDEO TAPES OR FOR PLAYING VIDEO GAMES. Such uses of this product may distract the driver or interfere with the driver's safe operation of the motor vehicle and may violate state law. **CLARION DISCLAIMS ANY LIABILITY FOR ANY BODILY INJURY, INCLUDING FATALITIES, OR PROPERTY DAMAGE THAT MAY RESULT FROM ANY SUCH UNINTENDED USES OR FROM ANY IMPROPER USE OF THIS PRODUCT.**

- Do not draw the LCD panel out and use it as a tray. Also, subjecting the LCD panel to shocks may result in breakage, deformation or other damage.

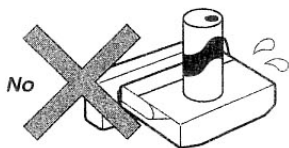

- Do not let cigarettes burn the display. Doing so may damage or deform the cabinet.

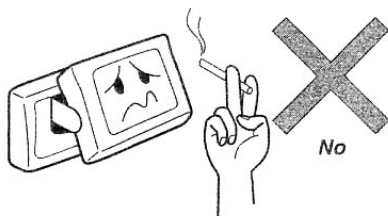

- If a problem should occur, have the set inspected at your store of purchase.
- Do not insert objects or poke in the space between the LCD panel and the source unit when the panel is tilted.
- Do not place anything on the display when the LCD panel is tilted.

- Do not hold on the LCD panel when adjusting the angle of the LCD panel. Doing so may damage it.
- In extremely cold weather, the movement of the picture may be slow and the display may be dark, but this is not a malfunction. The set will work normally once the temperature increases.
- Small black and shiny dots inside the LCD panel are normal for LCD products.
- The LCD panel may stop temporarily when it is opened or closed when the engine is stopped or when it is cold. This is not a malfunction. If this happens, repeat the operation.

Cleaning

• Cleaning the cabinet

Use a soft, dry cloth and gently wipe off the dirt.

For tough dirt, apply some neutral detergent diluted in water to a soft cloth, wipe off the dirt gently, then wipe again with a dry cloth.

Do not use benzene, thinner, car cleaner, etc., as these substances may damage the cabinet or cause the paint to peel. Also, leaving rubber of plastic products in contact with the cabinet for long periods of time may cause stains.

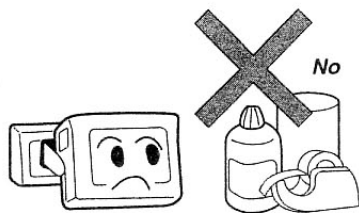

• Cleaning the LCD panel

The LCD panel tends to collect dust, so wipe it off occasionally with a soft cloth.

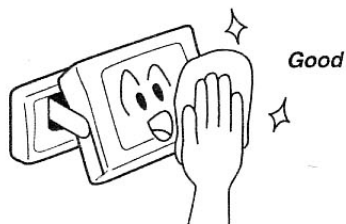

The surface is easily scratched, so do not rub it with hard objects.

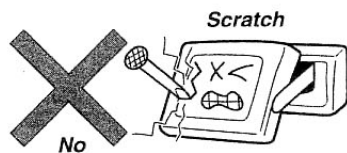

8. OPERATION

Basic Operations

Note: Be sure to read this chapter referring to the front diagrams of chapter "2. CONTROLS" on page 5 (spread).

! CAUTION

When this unit is turned on, starting and stopping the engine of a car with its volume raised to the maximum level may harm your hearing. Be careful about adjusting the volume.

NOTE: Use this unit after starting the engine.

Turning on the power and adjusting the volume

- 1) After turning the car's ignition switch on and starting the engine, press the POWER button **[7]** to turn on the power to the unit.
 - * This unit starts in the mode it was in when the power was turned off last.
- 2) Press the FUNC button **[7]** to select the operation mode.
Each time you press the FUNC button **[7]**, the operation mode changes as follows:

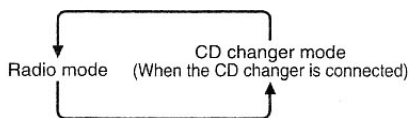

* Press and hold the FUNC button **[7]** for about one second to turn off the power.

- 3) Slide the Up/Down button **[1]** to ▲ (up) or ▼ (down) to adjust the volume.
 - ▲ : Increases the volume.
 - ▼ : Decreases the volume.
 - * The volume level indicated is in the display in a range from 0 (minimum) to 33 (maximum).

Note:

- In the CONFIGURATION or BALANCE display, the volume cannot be adjusted.

! CAUTION

While driving, keep the volume to a level at which external sounds can be heard.

! WARNING

THIS PRODUCT IS NOT INTENDED FOR VIEWING TELEVISION BROADCASTS OR VIDEO TAPES OR FOR PLAYING VIDEO GAMES. Such uses of this product may distract the driver or interfere with the driver's safe operation of the motor vehicle and may violate state law. CLARION DISCLAIMS ANY LIABILITY FOR ANY BODILY INJURY, INCLUDING FATALITIES, OR PROPERTY DAMAGE THAT MAY RESULT FROM ANY SUCH UNINTENDED USES OR FROM ANY IMPROPER USE OF THIS PRODUCT.

Opening and turning the display

- 1) Press the OPEN button **[5]** to open the Display **[12]**.

Notes:

- Do not place any object on the open display.
 - Do not drop any object on the movable part.
 - Do not expose the display to shocks.
 - * If the display is left horizontally in the open position for 10 seconds or longer, it is automatically drawn in.
- 2) Turn the display upwards to a good viewing angle.
When the display is turned upwards, a picture appears. Information panel display disappears.

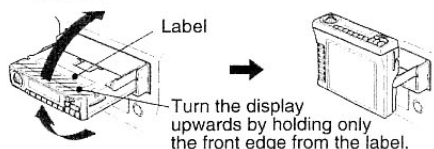

! CAUTION

Do not turn the display unless it is completely open.

When adjusting the angle of the display, be careful not to let your fingers get caught by the panel or instrument panel of the vehicle. Do not hold the part of the display beyond the label (see the illustration above).

- 3) To store the Display **12** in the source unit, turn it to the horizontal position until a click is heard.

* The display will be stored and the power to the source unit will be turned off automatically.

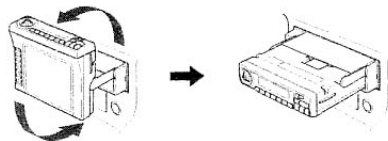

! CAUTION

Be careful not to let your fingers get caught when storing the panel.

Mounting and detaching the operation panel

The operation panel of this unit is detachable to prevent theft (DCP mechanism).

- 1) Move the DCP Lever **4** to the right. The operation panel is unlocked and comes out.

* The power is turned off at the same time.

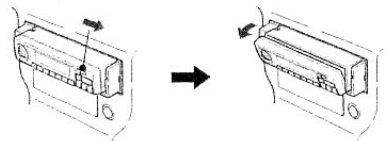

- 2) Pull the top edge of the Operation Panel **11** to remove it.

After removing the panel, put it in the attached DCP case for protection.

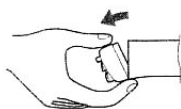

- 3) To mount the Operation Panel **11**, insert the panel's lower edge into the display edge and push the panel's upper edge until a click is heard.

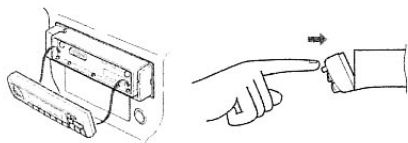

* Press the FUNC button **7** to turn on the power.

* Do not give an excessive force to the operation panel. Even after the operation panel is installed and locked, pulling it forcefully activates the sensor of the DCP and turns off the power to the unit, or may cause a breakdown.

Turning on and off the monitor

Each time you press the MONI button **17**, the monitor is turned on and off.

* When a button other than the volume adjustment button is pressed or during rear vision monitoring, the monitor-off mode is canceled.

Mute

Each time you press **▶/II** (center) of the ENT button **1**, mute is turned on and off.

"MUTE" is displayed when mute is turned on in radio mode, and "PAUSE" is displayed in CD changer mode.

Adjusting the tone

Notes:

• When the DSP or equalizer unit (DPH9100, DPH7100, or EQH5100) sold separately is connected to the source unit, the tone is adjusted by the DSP or equalizer unit and the tone adjustment mode cannot be selected. For further information, see the section "Operating the DSP and Equalizer."

• If no operation is made for about 5 seconds after each operation, the unit returns to the previous mode and the settings made are stored.

- 1) Press the AM button **3** to go to the tone adjustment mode.

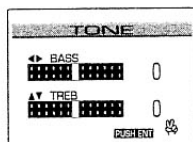

* BA (bass) and TR (treble) are displayed in the information panel **2**.

- Slide the Up/Down button **1** to ◀ (left), ▶ (right), ▲ (up), or ▼ (down) to adjust the tone.
 - ◀ (left) : Bass is attenuated.
 - ▶ (right) : Bass is emphasized.
 - ▲ (up) : Treble is emphasized.
 - ▼ (down) : Treble is attenuated.
- Press the AM button **3** to return to the previous mode.

Adjusting the balance

Note:

- If no operation is made for about 5 seconds after each operation, the unit returns to the previous mode and the settings made are stored.

- Press the AM button **3** to go to the tone adjustment mode.
- When the tone adjustment mode is displayed, press the following buttons to switch to the balance adjustment mode.

When the display is open: Press ▶/|| (center) of the ENT button **1**.

When the display is closed: Press the AM button **3**.

* BL (balance of right and left speakers) and FD (fader: balance of front and rear speakers) are displayed in the Information Panel **2**.

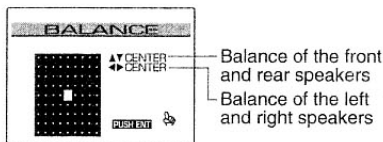

- Slide the Up/Down button **1** to ◀ (left), ▶ (right), ▲ (up), or ▼ (down) to adjust the balance of the speakers.
 - ◀ : Increases the volume of the left speaker.
 - ▶ : Increases the volume of the right speaker.
 - ▲ : Increases the volume of the front speaker.
 - ▼ : Increases the volume of the rear speaker.

Loudness

Notes:

- When the DSP or equalizer unit (DPH7100 or EQH5100) sold separately is connected to the source unit, the loudness effect cannot be selected.
- When the DSP unit DPH9100 sold separately is connected to the source unit, loudness cannot be adjusted. See the subsection "Setting the auto loudness effect" (page 28) to adjust loudness.

Press the LD button **3** for about 1 second. The loudness effect turns on and off.

*When the loudness effect is turned on, "LD" appears in the display.

Setting the clock

Note:

- This function is not available when the display is stored.

- 1) Press the ADJ button [15] to go to the CONFIGURATION display.
- 2) Slide the Up/Down button [1] to ▼ (down) or ▲ (up) and move the cursor to "CLOCK".

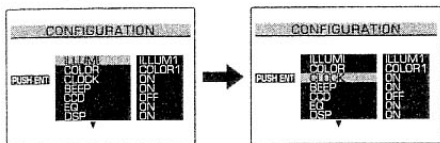

- 3) Press ►/|| (center) of the ENT button [1] to go to clock setting mode.

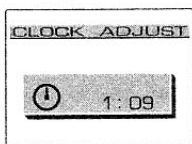

- 4) Slide the Up/Down button [1] to ◀ (left), ▶ (right), ▲ (up), or ▼ (down) to set a time. Increments the figure.



Selects the hour.

Selects the minute.

Decrements the figure.

- ◀ : Selects the hour (the hour becomes blue and can be changed).
- ▶ : Selects the minute (the minute becomes blue and can be changed).
- ▲ : The hour or minute increments while the corresponding figure is blue.
- ▼ : The hour or minute decrements while the corresponding figure is blue.

- 5) After adjusting the time, press ►/|| (center) of the ENT button [1] to set it.

* Pressing ►/|| (center) of the ENT button [1] resets the second to zero.

- 6) Pressing the ADJ button [15] returns the mode to the previous one.

Notes:

- The time is always displayed in radio and CD changer modes.
- When the clock mode is turned on when the display is stored, after a station is tuned in, the frequency is displayed for several seconds, then the time will be displayed.

Turning on and off the clock display

Note:

- This function is not available when the display is stored.

- 1) Press the ADJ button [15] to go to the CONFIGURATION display.
- 2) Slide the Up/Down button [1] to ▲ (up) or ▼ (down) to move the cursor to "CLOCK".

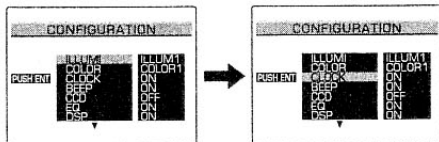

- 3) Each time you slide the Up/Down button [1] to ▶ (right), the clock display turns on and off.
- 4) Press the ADJ button [15] to return to the previous mode.

Radio Mode Operations

FM Reception

For enhanced FM performance the **MAGITUNE**[®] tuner includes signal actuated stereo control, Enhanced Multi AGC, Impulse noise reduction circuits and Multipath noise reduction circuits.

Listening to the radio

- 1) Press the FUNC button [7] to select radio mode.
- 2) Press the BAND button [8] to select a band. Each time you press the BAND button [8], the band changes in the following order:

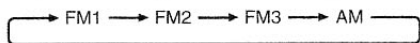

- 3) Press one of the preset buttons [9] to tune in to a station.

Seek tuning

- 1) While **MANU** appears in the display, press and hold the BAND button [8] for about 1 second to switch to the seek tuning.
- 2) Slide the Up/Down button [1] to ► (right) or ◀ (left) to start the seek tuning. When a station is found, it is automatically tuned in.
► : Seeks higher frequency stations.
◀ : Seeks lower frequency stations.
* To stop the seek tuning, slide the Up/Down button [1] to ◀ (left) or ► (right).

Manual tuning

- 1) When **MANU** does not appear in the display, press and hold the BAND button [8] for about 1 second to select manual tuning.
* When manual tuning is selected, **MANU** appears in the display.
- 2) Slide the Up/Down button [1] to ► (right) or ◀ (left) to tune in to a station.
* Each time you slide the Up/Down button [1], the frequency changes in 0.2 MHz increments for the FM and in 10 kHz increments for the AM band.
* Press and hold the Up/Down button [1] to ► (right) and ◀ (left) to increase or decrease the frequency continuously.

Preset memory function

A total of 24 stations can be preset, 6 each for the FM1, FM2, FM3, and AM bands.

Note:

- When a station is preset, the station previously stored in the memory at that position is cleared.

Manual memory function

- 1) Press the BAND button [8] to select a band.
- 2) Slide the Up/Down button [1] to ► (right) or ◀ (left) to tune in to a station.
- 3) Press and hold for about 2 seconds one of the Preset buttons [9] where you want to store the station. When a beep sounds, the station is stored in that button.
* One station in each band can be preset to each button.

Auto store function

Note:

- This function is not available when the display is stored.
- 1) Press the BAND button [8] to select a band.
 - 2) Press the DISP button [10] to select PS/AS mode.
* Press the DISP button [10] again to return to preset mode.
 - 3) When PS/AS mode is displayed, press No. 2 of the Preset buttons [9]. Stations with good reception are automatically stored in preset buttons starting from Preset button [9]. (After storing 6 stations, preset No. 1 station is tuned in and auto storing ends.)
* **A.S** in the display becomes pink.
* Stations with good reception are stored in the order from the current station to stations with a higher frequency. If there are fewer than 6 stations with good reception, the auto storing returns to the lowest frequency and resumes from there.

Note:

- When stations are preset by the auto store function, the station previously stored in the memory at that position is cleared. If there are fewer than 6 stations with good reception, the stations previously stored at the remaining preset buttons are not cleared.

Preset scanning

Note:

- This function is not available when the display is stored.

- 1) Press the BAND button [8] to select a band.
- 2) Press the DISP button [10] to select PS/AS mode.
 - * Press the DISP button [10] to return to preset mode.
- 3) In PS/AS mode, when No.1 of the Preset buttons [9] is pressed, the preset stations are tuned in for 5 seconds each.
 - * [P.S] in the display becomes pink.
 - * When a preset station has been tuned in, preset scanning starts from the station after the current one. When a preset station has not been tuned in, preset scanning starts from preset No. 1.
- 4) When a desirable station is tuned in, press No. 1 of the Preset buttons [9] to cancel PS/AS mode and press the preset button to which the station is to be stored.
 - * The preset scanning is canceled and you can listen to the station.

Preset selection

- 1) Press the BAND button [8] to select a band.
- 2) Press one of the Preset buttons [9] to select the stored station.

Note:

- In PS/AS mode, do not perform the preset selection (excluding the preset scanning).

In PS/AS mode, when No. 2 of the Preset buttons [9] is pressed, the auto storing starts and all the stored stations are cleared.

ISR memory

If an AM or FM station is stored in the ISR button, it can be directly tuned in by pressing the ISR button from any other mode.

- 1) Press the BAND button [8] to select a band.
- 2) Press the Preset button [9] or the ENT button [1] to tune in to a station you want to store.
- 3) Press and hold the ISR button [6] for about 2 seconds.

When a beep sounds, the display turns to the ISR (Instant Station Recall) display and the

frequency is stored.

- 4) Press the ISR button [6] to return to the previous mode.

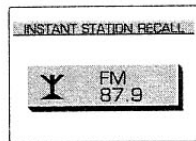

Calling the station with the ISR button

- 1) In any mode, pressing the ISR button [6] allows you to tune in to the stored station.
 - * When the ISR is functioning, the ISR display appears.
 - * The default ISR setting is 87.9 MHz.
- 2) To cancel the ISR function, press the ISR button [6] or FUNC button [7]. The ISR function is canceled and the previous mode returns.

Area change

When you listen to the radio outside the U.S., use this function.

Switchable frequency setting

This car stereo is initially set to tune in frequency intervals of 10 kHz for AM and 200 kHz for FM, the standard calibrations in the U.S. When using the unit outside the U.S., use the following procedure to switch the frequency range. The table below lists the frequency specifications for the U.S. and other countries.

| | | Initial Setting (U.S. standard) | New Setting (outside U.S.) |
|----|-------------------|---------------------------------|----------------------------|
| AM | Frequency spacing | 10 kHz | 9 kHz |
| | Frequency range | 530 to 1710 kHz | 531 to 1629 kHz |
| FM | Frequency spacing | 200 kHz | 50 kHz |
| | Frequency range | 87.9 to 107.9 MHz | 87.5 to 108 MHz |

Changing area

Note:

- This function is not available when the display is stored.

Depending on whether you use the unit in the USA and OTHER, switch the area as follows:

- 1) Press the ADJ button **[15]** to go to the CONFIGURATION display.
- 2) Slide the Up/Down button **[1]** to ▲ (up) or ▼ (down) and move the cursor to "AREA".
- 3) Slide the Up/Down button **[1]** to ► (right) to switch the area (between in the USA and OTHER).
* Set the USA usually.
- 4) Press the ADJ button **[15]** to return to the previous mode.
* The new setting returns to the initial setting.

CD Changer Mode Operations

This unit can control a separately sold CD changer to store and play up to 18 CDs.

Note:

- CD-ROM discs cannot be played.

Listening to a CD

- 1) Press the FUNC button [7] and select CD changer mode. Playback starts automatically.
- 2) Press one of the Disc No. buttons [9] (No.1 to No.6) corresponding to each CD to select one.

*The selected CD No. becomes pink in the display.

Note:

- If a slot in a magazine is empty, that slot No. does not appear in the display and cannot be selected.

- 3) Slide the Up/Down button [1] to ► (right) or ◀ (left) to select a track (song).

► : Selects the next track. (Example: The third track from the current one is selected by sliding the button 3 times.)

To return to the beginning of the current track, slide the Up/Down button [1] once to ◀ (left).

◀ : Selects the previous track. (Example: The third track before the current one is selected by sliding the button 1+3=4 times (the first sliding returns you to the beginning of the current track).)

Notes:

- After CD No. 6 is played, CD No. 1 is played again. However, when a CD changer capable of storing 12 or 18 CDs is connected to the unit, all CDs in all magazines are played sequentially (unless the magazine is locked).
- The empty slot No. is skipped and the next CD is played.

Fast-forward and fast-backward

- 1) Slide and hold the Up/Down button [1] to ► (right) and ◀ (left). The CD fast-forwards or fast-backwards while the button is being held.

► : Moves forward 3 times faster than normal play when you slide it for about 1 second and 15 times faster than normal play when you slide it for 5 seconds or longer.

◀ : Moves backward 3 times faster than normal play when you slide it for about 1 second and 15 times faster than normal play when you slide it for 5 seconds or longer.

Note:

- Slide the Up/Down button [1] to ► (right) or ◀ (left) for 1 second or shorter to switch the tracks.
- 2) Release the button when you reach the desired track to start playback.

Pausing playback

- 1) Press ►/II (center) of the ENT button [1] to pause playback.
* "PAUSE" appears in the display.
- 2) Press ►/II (center) of the ENT button [1] again to resume playback.

Scan play

This function plays the first 10 seconds of all the tracks on the current CD (track scan) or first 10 seconds of the first track of all the CDs in the CD changer (disc scan).

- 1) Press the DISP button [10] to select SCN/RPT/RDM mode.
- 2) Press No.1 of the Preset buttons [9] to start track scan. Scanning starts from the next track of the current one.
Press No.1 of the Preset buttons [9] for about 2 seconds to start disc scan. Scanning starts from the next disc of the current one.
* [SCN] becomes pink and [T-SCN] or [D-SCN] appears in the display.
* Turning off the power cancels scan play.
- 3) Press No.1 of the Preset buttons [9] when you reach the track you want to listen to. Playback resumes.

Repeat play

This function plays the current track (track repeat) or the current CD (disc repeat) repeatedly.

- 1) Press the DISP button [10] to select SCN/RPT/RDM mode.
- 2) Press No.2 of the Preset buttons [9] to start track repeat or press it for about 2 seconds to start disc repeat.

* **RPT** becomes pink and **T-RPT** or **D-RPT** appears in the display.

* To cancel track repeat or disc repeat, press No.2 of the Preset buttons **9** again. Playback resumes.

Random play

This function plays all the tracks on the current CD (track random) or plays the all CDs in the magazine (disc random) in random order.

1) Press the DISP button **10** to select SCN/RPT/RDM mode.

2) Press No.3 of the Preset buttons **9** to start track random or press it for about 2 seconds to start disc random.

* **RDM** becomes pink and **T-RDM** or **D-RDM** appears in the display.

3) When a track that you want to listen to is played, press No.3 of the Preset buttons **9** again to resume playback.

Switching the magazine

Note:

• This function is not available with the CD changer storing 6 CDs.

Press the MAGA button **8** to select a magazine.

Each time you press the MAGA button **8**, the magazine switches in the following order:

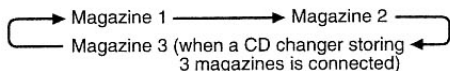

Playback starts from No. 1 CD in the selected magazine.

* The selected magazine No., DISC No., and TRACK No. appear in the display.



Locking the magazine

1) Press and hold the MAGA button **8** for about 2 seconds to play tracks on only the current CD.

* The selected magazine No. becomes pink in the display.

Notes:

- Even when the magazine is locked, pressing the MAGA button **8** switches to the new magazine which is locked.
- When the magazine is locked, scanning and random playback are performed only for the locked magazine.

2) To cancel, press and hold the MAGA button **8** for about 2 seconds. Playback resumes.

Adjusting the brightness and tone of color

Notes:

- This function is not available unless you stop the car and apply the parking brake.
- This function is not available when the display is stored.
- The brightness can be adjusted only when the picture of the rear vision camera is displayed.

- 1) Press the ADJ button [15] to select the CONFIGURATION display.
- 2) Slide the Up/Down button [1] to ▼ (down) or ▲ (up) to move the cursor to "DISPLAY".

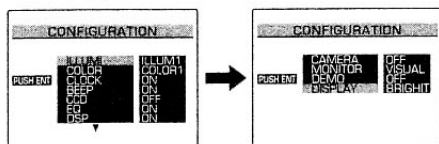

Adjusting the brightness

- 3) Slide the Up/Down button [1] to ► (right) to select either of BRIGHT, COLOR, or HUE. Each time you slide the Up/Down button [1] to ► (right), the adjustment mode switches in the following order:

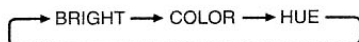

BRIGHT :Adjusts the brightness of the display.

COLOR :Adjusts the color saturation.

HUE :Adjusts the tone of color. (red is emphasized ↔ green is emphasized.)

- 4) Press ►/II (center) of the ENT button [1] to select what to adjust.

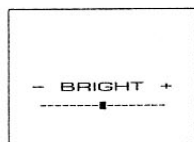

Darken. Brighten.
BRIGHT is selected.

- 5) Slide the Up/Down button [1] to ► (right) or ◀ (left) to adjust the brightness.

- 6) After the adjustment, press ►/II (center) of the ENT button [1] to return to the CONFIGURATION display.
- 7) Press the ADJ button [15] to return to the previous mode.

Other Functions

Note:

- The following operation is not available when the display is stored.

Switching the spectrum analyzer display

The spectrum analyzer display pattern can be switched in radio or CD changer mode.

Each time you press and hold the DISP button [10] for about 2 seconds, the spectrum analyzer display pattern switches in the following order:

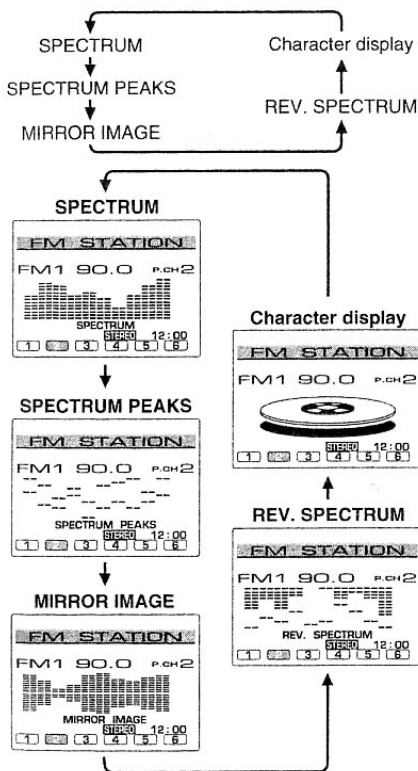

Notes:

- In ISR mode, the spectrum analyzer patterns cannot be displayed.
- The spectrum analyzer turns off temporarily in some mode or during some key operation.

Switching the button color

Button color can be switched between green and amber.

- 1) Press the ADJ button [15] to select the CONFIGURATION display.
- 2) Each time you slide the Up/Down button [1] to ► (right), the button color toggles between green (ILLUM1) and amber (ILLUM2).

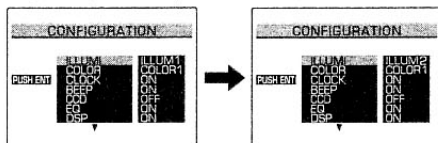

- 3) Press the ADJ button [15] to return to the previous mode.

Switching the background color

The background color of the display can be switched between blue and black.

- 1) Press the ADJ button [15] to select the CONFIGURATION display.
- 2) Slide the Up/Down button [1] to ▼ (down) or ▲ (up) to move the cursor to "COLOR".

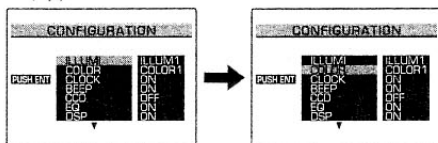

- 3) Each time you slide the Up/Down button [1] to ► (right), the background color toggles between blue (COLOR1) and black (COLOR2).
- 4) Press the ADJ button [15] to return to the previous mode.

Always turning on the button illumination on the operation panel

The button illumination on the operation panel, when the display is turned upward, can be switched between "AUTO" and "OFF".

AUTO: Button illumination on the operation panel turns on for 5 seconds.

OFF: Button illumination is always on when the power is turned on.

Note:

- This function is not available when the display is stored.

- 1) Press the ADJ button [15] to go to the CONFIGURATION display.
- 2) Slide the Up/Down button [1] to ▼ (down) or ▲ (up) to move the cursor to "DCP ILL."
- 3) Slide the Up/Down button [1] to ► (right) to switch indication "AUTO" to "OFF".
- 4) Press the ADJ button [15] to return to the previous mode.
* To set "AUTO" again, switch "OFF" to "AUTO" manually.

Turning on and off the operation sound

You can turn off the beep sound output during operation.

- 1) Press the ADJ button [15] to select the CONFIGURATION display.
- 2) Slide the Up/Down button [1] to ▼ (down) or ▲ (up) to move the cursor to "BEEP"

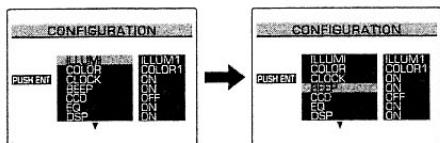

- 3) Each time you slide the Up/Down button [1] to ► (right), the beep sound is turned on and off.
- 4) Press the ADJ button [15] to return to the previous mode.

Titling

You can title a radio station or CD name (title) and store them. When the titled station is tuned in or the CD is played, its title appears in the display.

Entering a title

Notes:

- Up to 30 FM band and 20 AM band stations can be titled. Also 50 CDs can be titled.
 - If you try to input more than the specified number of titles, "OVER FLOW" appears in the display and further input becomes impossible. Delete unnecessary titles to input new ones.
 - A CD title can be entered only when it is played.
- 1) Select a station or CD which you want to title.
 - 2) Press the TITLE button [16] and select the title input display.

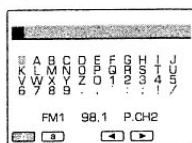

* Each time you press the TITLE button [16], the display switches in the following order:

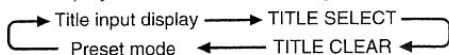

- 3) Press No. 1 and No. 2 of the Preset buttons [9] to select the letter type.

No. 1 of the Preset buttons [9]: Upper case letters and figures

No. 2 of the Preset buttons [9]: Lower case letters and symbols

- 4) Slide the Up/Down button [1] to ▲ (up), ▼ (down), ◀ (left), or ▶ (right) to move the pink cursor to the letter you want to enter. Press ►/II (center) of the ENT button [1]. The selected letter is entered at the cursor (black) on the top of the display.

- * Repeat steps 3) and 4) above to enter the title.
- * If you entered the wrong letter, press No. 4 of the Preset buttons [9] to backspace the cursor (black) and enter the correct letter this time.
- * Press No. 5 of the Preset buttons [9]. The cursor (black) moves to the right.

- 5) After entering the title, press and hold **▶/||** (center) of the ENT button **[1]** for about 2 seconds.

* The title is stored when the beep sounds and the previous mode is recalled.

Notes:

- The title list of the title select display in radio mode displays only titles for the preset stations.
- After entering a title, if you change the reception area, inconsistency between the entered title and the frequency occurs.

Clearing the title

- 1) Select the mode where the title you want to clear is stored (radio or CD changer mode).
- 2) Press the TITLE button **[16]** to go to the TITLE CLEAR display.

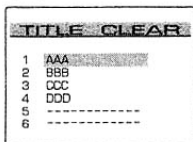

- 3) Slide the Up/Down button **[1]** to **▼** (down) or **▲** (up) to move the cursor to the title you want to clear and press and hold **▶/||** (center) of the ENT button **[1]** for about 2 seconds. The title is cleared when the beep sounds.
- 4) Press the TITLE button **[16]** to return to the previous mode.

Changing the title

- 1) Select the mode where the title you want to change is stored (radio or CD changer mode).
- 2) Press the TITLE button **[16]** to select the title input display.
Change the title using the procedure described in step 3) above and in the subsection "Entering a title" (page 24).

Selecting the title

- 1) Select the mode where the title you want to select is stored (radio or CD changer mode).
- 2) Press the TITLE button **[16]** twice to select the TITLE SELECT display.
The entered titles appear after the title numbers.

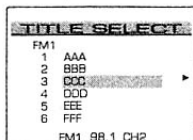

- * In CD mode, the TITLE SELECT display cannot be selected.
 - * In radio mode, slide the Up/Down button **[1]** to **◀** (left) or **▶** (right) to select a band.
- 3) Slide the Up/Down button **[1]** to **▼** (down) or **▲** (up) to move the cursor to the title to be selected. Press **▶/||** (center) of the ENT button **[1]** to tune in to the selected station.
* Press the TITLE button **[16]** twice to quit the TITLE SELECT display.

Operating the DSP and Equalizer

Notes:

- To use the functions described in this section, the DSP (Digital Sound Processor) DPH9100 or DPH7100, sold separately; or the EQ (Equalizer) EQH5100 must be connected to the source unit. Also, some functions are restricted to certain connection units. Therefore, the model numbers of the units which incorporate each function are indicated in the instructions hereafter.
- The functions described in this section are not available when the display is set.
- When the DPH9100, DPH7100, or EQH5100 is connected to the source unit, the tone cannot be adjusted as in the regular mode.

The DSP and EQ can;

- Adjust the listening position (when the DPH9100 or DPH7100 is connected).
- Set the sound setting (when the DPH9100 or DPH7100 is connected).
- Adjust the sound range (when the DPH9100, DPH7100, or DQH5100 is connected).
- Enter titles (when the DPH9100 is connected).

Adjusting the listening position

By adjusting the sound propagation time based on seat position, a natural sound setting can be created.

Notes:

- This function is available only when the DPH9100/DPH7100, sold separately, is connected.
- If the control is idle for about 5 seconds after each operation, the unit returns to the previous mode.

- 1) Press the AM button [3] to change the display to the listening position adjustment mode.
- 2) Slide the Up/Down button [1] to ▼ (down) or ▲ (up) to select the listening position.

* Each time you slide the Up/Down button [1], the adjustment position changes as follows:

The selected position is displayed in white.

- FULL SEAT** : Center of the cabin space
FRONT-R : Right side of the front seats
FRONT-L : Left side of the front seats
FRONT : Center of the front seats
REAR : Center of the rear seat
POSITION PASS : Usual adjustment

- 3) Press ▶/|| (center) of the ENT button [1] to select the balance adjustment mode.
- 4) Slide the Up/Down button [1] to ▲ (up), ▼ (down), ◀ (left), or ▶ (right) to adjust the balance.
- 5) Press ▶/|| (center) of the ENT button [1] to enter the adjustment or wait for about 5 seconds.
The display returns to the listening position adjustment mode.

Changing the DSP characteristics

The DSP creates the surround effect in the cabin space without deteriorating sound quality through digital signal processing.

Selecting the sound setting menu

The sound setting menu can be selected from the provided DSP menu or from the DSP characteristics selected by yourself.

Notes:

- This function is available only when the DPH9100/DPH7100 is connected.
- If the control is idle for about 5 seconds after each operation, the unit returns to the previous mode.

- 1) Press the DSP button [13] to select the DSP mode.
- 2) Press the BAND button [8] to select DSP BASIC or DSP USER.

* When the DPH7100 is connected, only the DSP BASIC menu (same as the DSP BASIC1 for the DPH9100) is displayed.

* Each time you press the BAND button [8], the DSP menu changes in the following order:



DSP BASIC1,2: Each menu consists of 6 characteristics initially set.

DSP USER : This menu is an adjustment menu to be set by the user (for setting the menu, see the next subsection "Setting your own DSP characteristics").

- 3) Press one of the Preset buttons [9] (No. 1 to No. 6) and select the DSP menu to be set.

<DSP BASIC1> (for DPH9100/DPH7100)

| | | |
|------|-----------------|--|
| No.1 | HAL(HALL) | Sound setting simulating a large hall |
| No.2 | CHC(CHURCH) | Sound setting simulating a big church with a very high ceiling |
| No.3 | SDM(STADIUM) | Sound setting simulating a large stadium with no fence or ceiling |
| No.4 | LVH(LIVE HOUSE) | Sound setting simulating a live house slightly larger than a jazz club |
| No.5 | DIS(DISCO) | Sound setting simulating a disco where the bass is emphasized |
| No.6 | JAZ(JAZZ CLUB) | Sound setting simulating a jazz club with a low ceiling |

<DSP BASIC2> (only for DPH9100)

| | | |
|------|--------------|---|
| No.1 | DOM(DOME) | Sound setting simulating an indoor sports ground |
| No.2 | CHM(CHAMBER) | Sound setting simulating a grand chamber of a court |
| No.3 | PRK(PARK) | Sound setting simulating a large outdoor field |
| No.4 | THE(THEATER) | Sound setting simulating a movie house or theater |
| No.5 | STU(STUDIO) | Sound setting simulating a listening room |
| No.6 | BGM(BGM) | Vocal sound is eliminated. |

<DSP USER> (only for DPH9100)

| | | |
|------|--------------|------------------|
| No.1 | US1(DSP U-1) | Set by the user. |
| No.2 | US2(DSP U-2) | Set by the user. |
| No.3 | US3(DSP U-3) | Set by the user. |
| No.4 | US4(DSP U-4) | Set by the user. |
| No.5 | US5(DSP U-5) | Set by the user. |
| No.6 | US6(DSP U-6) | Set by the user. |

Note:

- Turn on the DSP effect after following instructions in the next subsection, "Turning on and off the DSP effect." Otherwise, the above settings will be invalidated.

Turning on and off the DSP effect

- 1) Press the ADJ button [15] and go to the CONFIGURATION mode.
- 2) Slide the Up/Down button [1] to ▼ (down) or ▲ (up) to move the cursor to "DSP".
- 3) Slide the Up/Down button [1] to ► (right) to turn "OFF" and "ON".
- 4) Press the ADJ button [15] and return to the previous mode.

Setting your own DSP characteristics

Up to 6 DSP characteristics can be set by the user and stored in the DSP USER (US-1 to US-6).

Notes:

- This function is available only when the DPH9100 (sold separately) is connected to the source unit.
- If the control is idle for about 5 seconds after each operation, the unit returns to the previous mode.
- If DSP is turned off in the CONFIGURATION mode, the following instructions cannot be operated.

- 1) Press the DSP button [13] to go to the DSP mode.
- 2) Press the BAND button [8] to select DSP USER.
- 3) Press the ADJ button [15] when DSP USER is displayed to select the adjustment menu.
- 4) Press ►/|| (center) of the ENT button [1] to go to the "DSP EDIT" adjustment mode. Adjustment items are displayed as shown on the next page.

To move the cursor to the next item, slide the Up/Down button [1] to ► (right) and to move it to the previous item, slide the button to ◀ (left). (If you slide and hold the Up/Down button [1] to ◀ (left), the adjustment menu returns.) (*1 in the table on the next page) Slide the Up/Down button [1] to ▲ (up) and ▼ (down) to change each set value (*2 in the table on the next page).

Note:

- The sound setting menu "DSP BASIC1" has already been set in DSP USER.

| Adjustment items *1 | Description*2 | Remarks |
|---------------------|---|--|
| EFFECT | Slide the button to ▲ (up) or ▼ (down) to set the sound reflection ratio. (0 to 100%) | |
| INITIAL DELAY | Slide the button to ▲ (up) or ▼ (down) to set the distance from the sound source. (1 ms to 100 ms) | The BGM type pattern*3 in the DSP menu can not be adjusted. |
| REVERB TIME | Slide the button to ▲ (up) or ▼ (down) to set the reverberation time. (0.3 s to 10.0 s) | Only the reverberation type pattern*4 in the DSP menu can be adjusted. |
| ROOMSIZE | Slide the button to ▲ (up) or ▼ (down) to set the sound expansion. (0.1 to 1.0) | Only the early reflection type pattern*5 in the DSP menu can be adjusted. |
| HIGH | Slide the button to ▲ (up) or ▼ (down) to set the reverberation ratio for high frequency sounds. (0.1 to 1.0) | Only the reverberation type pattern*4 in the DSP menu can be adjusted. |
| LIVENESS | Slide the button to ▲ (up) or ▼ (down) to adjust the echo. (0 to 10) | Only the early reflection type pattern *5 in the DSP menu can be adjusted. |

*3: The BGM type pattern indicates "BGM" in BASIC2.

*4: The reverberation type pattern indicates "HALL" and "CHURCH" in BASIC1, and "DOME" and "CHAMBER" in BASIC2.

*5: The early reflection type pattern indicates "STADIUM", "LIVE HOUSE", "DISCO", and "JAZZ CLUB" in BASIC1, and "PARK", "THEATER", and "STUDIO" in BASIC2.

- After setting the pattern, press and hold one of the Preset buttons [9] (No. 1 to No. 6) at which you want to store the pattern.

* A beep sounds when the pattern is set.

- Press the DSP button [13] to return to the previous mode.

Setting the auto loudness effect

The auto loudness effect can be turned on and off, or adjusted.

Notes:

- This function is available only when the DPH9100 (sold separately) is connected to the source unit.
- If the control is idle for about 5 seconds after each operation, the unit returns to the previous mode.

Turning on and off the auto loudness effect

- Press the DSP button [13] to go to the DSP mode.
- Press the ADJ button [15] to display the adjustment menu.
- Slide the Up/Down button [1] to ▼ (down) to select "A.LD ADJ".
- Slide the Up/Down button [1] to ► (right) to turn on and off the auto loudness effect.
- Press the DSP button [13] to return to the previous mode.

Adjusting the sound level of the auto loudness effect

The sound level of the auto loudness effect can be adjusted in 11 levels (0 to 10).

Notes:

- In order to make the following adjustments, you must turn on the "A.LD ADJ" described in step 3) in the previous subsection.
- The adjusted sound level cannot be stored in "USER1 to 6".

- Press the DSP button [13] to go to the DSP mode.
- Press the ADJ button [15] to display the adjustment menu.
- Slide the Up/Down button [1] to ▼ (down) to select "A.LD ADJ" and press ►/II (center) of the ENT button [1] to go to the auto loudness effect adjustment mode. The adjustment display appears.
- Slide the Up/Down button [1] to ▲ (up) or ▼ (down) to select the sound level.
- Press the DSP button [13] to return to the previous mode.

Modifying the equalizer characteristics

The equalizer selects the appropriate sound features and frequencies for each type of music.

Selecting the equalizer characteristics

You can select the equalizer characteristics from the provided equalizer menu or from the equalizer characteristics which have been selected by the user.

Note:

- If the control is idle for about 5 seconds after each operation, the unit returns to the previous mode.

1) Press the EQ button [14] to go to the equalizer mode.

2) Press the BAND button [8] to select EQ BASIC or EQ USER.

Each time you press the BAND button [8], the EQ BASIC and EQ USER toggles.

EQ BASIC: This menu consists of the 6 equalizer characteristics initially set.

EQ USER: The menu containing user-set equalizer characteristics (for setting the characteristics, see the next subsection "Setting and storing the equalizer characteristics." The equalizer No. where no setting is made becomes flat.)

3) Press No. 1 to 6 of the preset buttons [9] to select the equalizer characteristic to be set.

| Button No. | EQ BASIC | EQ USER |
|------------|--|---------|
| No.1 | BAS (BASS BOOST) Bass is emphasized. | US1 |
| No.2 | HIG (HIGH BOOST) Treble is emphasized. | US2 |
| No.3 | ACO (ACOUSTICAL) Mean (human voice) is emphasized. | US3 |
| No.4 | IMP (IMPACT) Bass and treble are emphasized. | US4 |
| No.5 | SMO (SMOOTH) Sound level of each band is smoothed. | US5 |
| No.6 | FLA (FLAT) Original sound (flat equalizing) | US6 |

Note:

- Turn on the equalizer effect after following the instructions in the next subsection "Turning on and off the equalizer effect." Otherwise, the above settings will be invalidated.

Turning on and off the equalizer effect

- 1) Press the ADJ button [15] to go to the CONFIGURATION mode.
- 2) Slide the Up/Down button [1] to ▼ (down) or ▲ (up) to move the cursor to "EQ".
- 3) Slide the Up/Down button [1] to ► (right) to turn "OFF" and "ON".
- 4) Press the ADJ button [15] to return to the previous mode.

Setting and storing the equalizer characteristics

You can set your own equalizer characteristics and store them to "EQ USER" (US1 to US6). Up to 6 patterns can be stored.

Notes:

- This setting cannot be edited when EQ in the CONFIGURATION display is turned off.
- If the control is idle for about 5 seconds after each operation, the unit returns to the previous mode.

1) Press the EQ button [14] to go to the equalizer mode.

2) Press the BAND button [8] to select "EQ USER."

3) Press ►/|| (center) of the Up/Down button [1] when the "EQ USER" is displayed.

4) Slide the Up/Down button [1] to ◀ (left) or ▶ (right) to select the frequency and slide to ▲ (up) or ▼ (down) to adjust the sound level.

* Repeat the above procedures to set the characteristics.

* The frequency selection option differs according to the connection unit as follows:

| DSP/EQ type | Frequency to be selected | Sound level to be adjusted |
|--------------------|--|----------------------------|
| DPH9100 DPH7100 | 30/50 Hz, 100 Hz, 200 Hz, 400 Hz, 1 kHz, 3 kHz, 12 kHz | -12 dB to +12 dB |
| EQH5100 | 30 Hz, 60 Hz, 120 Hz, 200 Hz | -15 dB to +15 dB |
| | 400 Hz, 1 kHz, 3 kHz, 8 kHz, 12 kHz | -12 dB to +12 dB |

- 5) After setting the characteristics, press and hold one of the Preset buttons [9] (No. 1 to No. 6) where you want to store the setting. A beep sounds when the setting is stored.
- 6) Press the EQ button [14] to return to the previous mode.

Other equalizer settings

Basic settings

The following items can be set for the equalizer.

- ◆ **No. of sub woofers:** STEREO/MONO/OFF
(SUB WOOFER: when sub woofers are connected)
- ◆ **Lowest frequency:** 30 Hz/50 Hz
(EQ MINFREQ: when the DPH9100 or DPH7100 is connected)
- ◆ **Parametric equalizer adjustment:**
FRONT/REAR /OFF
(P. EQ: when the DPH9100 is connected)
- ◆ **Turning on and off the surround effect:**
ON/OFF
(SURROUND: when the EQH5100 is connected)

Note:

- ◆ If the control is idle for about 5 seconds after each operation, the unit returns to the previous mode.

- 1) Press the EQ button [14] to go to the equalizer mode.
- 2) Press the ADJ button [15] to display the setting menu.
- 3) Slide the Up/Down button [1] to ▲ (up) and ▼ (down) to select the item and slide the Up/Down button [1] to ► (right) to change the setting.

The following items can be set.

- ◆ **SUB WOOFER:** STEREO/MONO/OFF
Switches the settings according to the no. of speakers.
- ◆ **EQ MINFREQ:** 30/50
Sets the lowest frequency.
- ◆ **P. EQ:** FRONT/REAR/OFF
Switches the front and rear.
- ◆ **SURROUND:** ON/OFF
Turns on and off the surround effect.

When setting the item SUB WOOFER or P. EQ in "PUSH ENT", if you press ►/|| (center) of the ENT button [1], the adjustment mode is set. For information about the adjustment mode of each item, see the next subsection "Setting in the adjustment mode".

- 4) After completing the setting, press the EQ button to return to the previous mode.

Setting in the adjustment mode

Note:

- ◆ When the sub woofer or parametric equalizer is turned off, it cannot be adjusted.

Select an item to be adjusted following step 3) in the previous subsection "Basic settings" and press ►/|| (center) of the ENT button [1]. The setting mode is displayed and each adjustment window is displayed.

Slide or press the Up/Down button [1] following the instruction on the display and make setting.

Adjusting the sub woofer

Volume or filter of the sub woofer is set.

Items shown in the table below can be set.

| Items*1 | Description |
|-------------|--|
| WOOFER VOL | Slide the Up/Down button [1] to ▲ (up) or ▼ (down) to adjust the volume of the woofer. (0 to 4) |
| LPF | Slide the Up/Down button [1] to ▲ (up) or ▼ (down) to set the frequency of the low pass filter. (50 Hz ↔ 80 Hz ↔ 120 Hz) |
| LPF SLOP*2 | Slide the Up/Down button [1] to ▲ (up) or ▼ (down) to set the slope of low pass filter. (12 dB/oct ↔ 18 dB/oct ↔ 24 dB/oct) |
| HPF | Slide the Up/Down button [1] to ▲ (up) or ▼ (down) to set the frequency of the high pass filter. (Through ↔ 50 Hz ↔ 80 Hz ↔ 120 Hz) |
| HPF SLOP*2 | Slide the Up/Down button [1] to ▲ (up) or ▼ (down) to set the slope of high pass filter. (off ↔ FRONT-L ↔ FRONT-R ↔ REAR-L ↔ REAR-R ↔ WOOFER-L ↔ WOOFER-R ↔ ALL ch) |
| TEST TONE*3 | Slide the Up/Down button [1] to ▲ (up) or ▼ (down) to check the wiring of the speakers. (off ↔ FRONT-L ↔ FRONT-R ↔ REAR-L ↔ REAR-R ↔ WOOFER-L ↔ WOOFER-R ↔ ALL ch) |

*1: To move the cursor to the next item, slide the Up/Down button [1] to ► (right), and to the previous item, slide the button to ◀ (left). (If you slide and hold the Up/Down button [1] to ◀ (left), the adjustment menu returns.)

*2: The LPF SLOPE and the HPF SLOPE can be adjusted when the DPH9100 is connected.

*3: The TEST TONE can be adjusted when the DPH9100/DPH7100 is connected.

Note:

- ◆ The setting for the sub woofers cannot be preset in "USER1 to 6".

Adjusting the parametric equalizer

Frequency characteristic in the cabin space can be adjusted.

The items shown in the table below can be adjusted.

- Press **▶/||** (center) of the ENT button **[1]** to output the TEST TONE (PINK NOISE) in the following order.

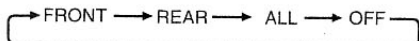

- * The preset selection display appears first.

Note:

- The settings made for the parametric equalizer cannot be preset in "USER1 to 6."

| Items*1 | Description |
|-------------------------------|---|
| FRONT ^{*2} PRESET | Slide the Up/Down button [1] to ▲ (up) or ▼ (down) to select one out of 6 parameters according to the vehicle type. (TYPE1 to TYPE6) |
| REAR ^{*2} PRESET | Slide the Up/Down button [1] to ▲ (up) or ▼ (down) to select one out of 7 parameters according to the vehicle type. (TYPE1 to TYPE7) |
| BAND | Slide the Up/Down button [1] to ▲ (up) or ▼ (down) to select the band to be adjusted. Select 1 and 2 to adjust the bass, and 3 and 4 to adjust the treble and mean. (1 to 4) |
| FRE- QUENCY | Slide the Up/Down button [1] to ▲ (up) or ▼ (down) to select the range of the frequency to be adjusted. (Set BAND1 and 2 to select the frequency range between 20 Hz and 500 Hz, or set BAND3 and 4 to select the range between 630 Hz and 20 kHz.) |
| GAIN | Slide the Up/Down button [1] to ▲ (up) or ▼ (down) to adjust the sound level. (-12 dB to +12 dB) |
| Q | Slide the Up/Down button [1] to ▲ (up) or ▼ (down) to select the magnitude of vibration. (1, 3, 5, 7, 20) |

*1: To move the cursor to the next item, slide the Up/Down button **[1]** to ▶ (right), and to the previous item, slide the button to ◀ (left). (If you slide and hold the Up/Down button **[1]** to ◀ (left), the adjustment menu returns.)

*2: Select "REAR" or "FRONT" of "P.EQ" in the EQ ADJ display beforehand.

Turning on and off the surround effect

Slide the Up/Down button **[1]** to ▶ (right) to turn on and off the surround effect.

Titling the DSP and equalizer menu



Note:

- This function is available only when the DPH9100 (sold separately) is connected.
- 1) Press the DSP button **[13]** or the EQ button **[14]**, whichever you want to title.
 - 2) Press the BAND button **[8]** and one of the Preset buttons **[9]** (No. 1 to No. 6) to select a user No. to be titled.
 - 3) Press the TITLE button **[16]** when the menu is displayed to go to the title input display.
To enter a title, see the subsection "Titling" (page 24).
* Press the TITLE button **[16]** to cancel the titling.

Note:

- Up to 11 characters can be entered in one title.

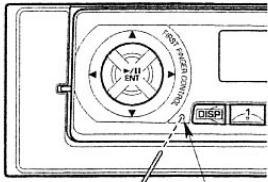
9. TROUBLESHOOTING

| Symptom | Cause | Measure |
|---|---|--|
| Power does not switch on. (There is no sound produced.) | The fuse has blown. | Replace the fuse with one of the same rating (0.5 A or 10 A for this unit). If the fuse blows again, contact the store where you purchased the unit. |
| | Wiring is incomplete. | See "Installation/Wire Connection Guide (especially, Section 7. Wire Connections)" of this manual and connect properly. |
| Nothing happens when buttons are pressed, or the display is not accurate. | Noise, etc., is causing the microprocessor to malfunction. | Press the reset button with the tip of a very fine instrument for about 2 seconds.  <p>Tip of a very fine instrument</p> <p>Reset button</p> |
| DSP/EQ does not operate. | The switch of the tuner unit is set to "N." | Turn off the ignition switch once and set the switch to "D." |
| Picture does not appear. | Parking brake is not applied. | Check that the parking brake is fully applied. |
| Picture has shadow or shadows. | Signal condition is poor. | This may be due to signals reflected off mountains or buildings. Check again in a different place and direction. |
| LCD panel is not drawn in when it is set to the horizontal position. | Foreign object at back of tray | The panel will not be properly drawn in if there is an object on the tray in the TV storage compartment. Remove the object. |
| Screen is dark. | Brightness is adjusted too low. | Check that the brightness is properly adjusted in the CONFIGURATION mode and set it properly. |
| | Usage conditions are poor. | This may happen if the temperature in the car is below 32°F (0°C) or above 140°F (60°C). Check again when the temperature is between 32°F (0°C) to 140°F (60°C). |
| The power was turned off when driving on bumpy roads. | Severe vibration to the operation panel activated the DCP's sensor. | Press the POWER button  again to turn the power on. |

| Symptom | Cause | Measure |
|---|---|---|
| Colors are pale or hue is poor. | COLOR (tone of color) and HUE are not adjusted appropriately. | Select the CONFIGURATION display and adjust the color and hue density using the COLOR and HUE controls. |
| Spots or stripes on picture | Interference signals | This may be caused by interference from other cars, trains, high voltage lines, neon lights, etc. Check again in another place. |
| The compact disc does not enter. | There is already a compact disc inside the disc insertion slot. | Eject the compact disc and then insert another one. |
| The compact disc soon comes out again. | The compact disc has been inserted upside down. | Insert the compact disc with the labeled side facing up. |
| Sound skipping noise and other noise are heard. | The compact disc is dirty. | Wipe the compact disc with a soft cloth. |
| | The compact disc is severely scratched or warped. | Replace the compact disc with one that is in good condition. |
| The sound is poor immediately after switching on the power. | When the car is parked in a humid place, dew might form on the internal lens. | Turn the unit on and wait for about 1 hour before operating. |

10. ERROR DISPLAYS

- If an error occurs, the type of error is displayed.
Take the measures described below to eliminate the problem.

| Error display | Name of error | Description |
|---------------|-------------------|---|
| ERROR 1 | Memory error | This error occurs if the disc loading data, etc., is lost due to wear of the CD auto changer's battery. (Remove all the discs from the magazine, insert the empty magazine and press the eject key to return to the first disc.) |
| ERROR 2 | Mechanical error | This error occurs if there is a problem with the mechanism and the eject or disc selection operation is not completed in the specified amount of time. (Consult the nearest Clarion service shop or customer clinic.) |
| ERROR 3 | Functional error | This error occurs if the pickup cannot focus after several tries due to scratches on the disc, signal interference, etc. (Replace the disc.) |
| ERROR 6 | Disc error | This error occurs when the disc is loaded upside-down. (Reload the disc properly.) |
| TEMP ERROR | Temperature error | This error occurs when the CD mechanism's temperature sensor detects that the temperature is too high. (When the temperature returns to normal, playback starts.) |

11. SPECIFICATIONS

FM Tuner

Frequency range: 87.9 MHz to 107.9 MHz (87.5 MHz to 108 MHz)

Usable sensitivity: 12 dBf (new IHF)

50 dB quieting sensitivity: 18 dBf (new IHF)

Signal-to-noise ratio: (IHF·A) 70 dB

Frequency response: 30 to 15 kHz ± 3 dB

Stereo separation: 35 dB (1 kHz, 60 dBf)

AM Tuner

Frequency range: 530 kHz to 1710 kHz (531 kHz to 1629 kHz)

Usable sensitivity: 28 dB (μ V)

Signal-to-noise ratio: 50 dB (monaural)

Audio Amplifier

Rated power output: 14 W \times 4 (20 Hz to 20 kHz, 1%, 4 Ω)

Maximum power output: 30 W \times 4 (EIAJ)

Speaker impedance: 4 Ω (4 to 8 Ω)

LCD Display

Screen size: 5-inch

(4" (102 mm) Width \times 2-15/16" (74mm) Height)

Display method: Transmission type TN liquid crystal display

Drive method: TFT (thin-film transistor) active matrix driving

Pixels: 224,640 (960 \times 234)

General

Power source voltage: 14.4 V DC

Ground: Negative

Current consumption: 4.0 A (1 W)

Dimensions (source unit): 7" (178 mm) Width \times 2" (50 mm) Height \times 6-1/8" (156 mm) Depth

Dimensions (tuner amplifier unit): 7" (178 mm) Width \times 1-1/2" (38 mm) Height \times 7-3/4" (196 mm) Depth

Weight (source unit): 3.30 lb. (1.5 kg)

Weight (tuner amplifier unit): 2.42 lb. (1.1 kg)

Source Unit

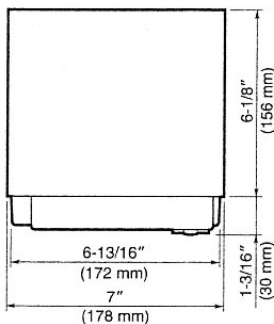

Unit: inch (mm)

Tuner Amplifier Unit

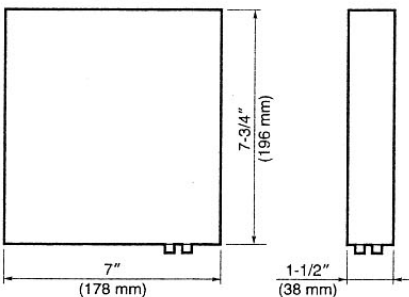

Notes:

- Specifications comply with EIAJ Standards.
- Specifications and design are subject to change without notice for further improvement.

■ Contents

| | |
|-------------------------------------|----|
| 1. BEFORE STARTING | 37 |
| 2. PACKAGE CONTENTS | 38 |
| 3. CAUTIONS ON INSTALLATION | 38 |
| 4. INSTALLING THE SOURCE UNIT | 39 |
| 5. REMOVING THE SOURCE UNIT | 41 |
| 6. CAUTIONS ON WIRING | 42 |
| 7. WIRE CONNECTIONS | 43 |
| 8. SAMPLE SYSTEMS | 45 |
| 9. GENERAL CAUTIONS | 46 |

⚠ WARNING

This product must be installed and used only in accordance with these instructions. DO NOT CONNECT A TELEVISION TUNER TO THIS PRODUCT OR OTHERWISE ALTER THIS PRODUCT SO THAT IT CAN BE USED FOR RECEIVING TELEVISION BROADCAST SIGNALS OR FOR PLAYING VIDEO TAPES OR VIDEO GAMES. Any alteration of this product that enables it to be used in ways other than those provided for in this manual could distract the driver and result in an accident for which the installer may be held liable. CLARION DISCLAIMS ANY LIABILITY THAT MAY RESULT FROM A FAILURE TO INSTALL AS INDICATED IN THESE INSTRUCTIONS.

1. BEFORE STARTING

1. This set is exclusively for use in cars with a negative ground 12 V power supply.
2. Read these instructions carefully.
3. Be sure to disconnect the battery "⊖" terminal before starting. This is to prevent short circuits during installation. (Figure 1)

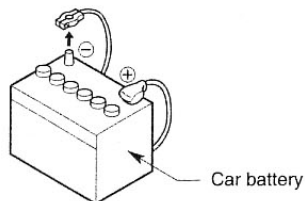

Figure 1

2. PACKAGE CONTENTS

- | | |
|--|---|
| ① Source unit | ⑨ Bag for accessories of the source unit (No. 1) |
| ② Tuner amplifier unit | Flat head screw (M5 × 8)4 |
| ③ Manuals | Sems hexagonal bolt (M5 × 8)5 |
| Owner's Guide & Installation | ⑩ Bag for accessories of the source unit (No. 2) |
| Warranty card | Hook plate2 |
| ④ Connection lead | Zip tie |
| (for the source unit and the tuner amplifier unit) | Spacer |
| ⑤ Antenna extension lead | Mounting screw |
| ⑥ Power supply lead | ⑪ Bag for accessories of the tuner amplifier unit |
| (for the tuner amplifier unit) | Mounting bracket2 |
| ⑦ Parking sensor extension lead | Plastic blind clip4 |
| (orange) | Mounting screw (M4 × 8)4 |
| ⑧ Extension lead for rear vision camera | ⑫ Universal mounting bracket |
| (white/red) | ⑬ DCP case |

3. CAUTIONS ON INSTALLATION

- Prepare all articles necessary for installing the source unit before starting.
- This model is used with the LCD panel slid forwards (shell loading system). On some types of cars, the LCD panel may touch the dashboard or shift stick, in which case it cannot be installed. Check that the set will not hamper operation of the shift stick before choosing the place of installation. (Figure 2)
- If you have to do any work on the car body, such as drilling holes, consult your car dealer beforehand.
- Use the enclosed screws for installation. Using other screws can cause damage. (Figure 4)

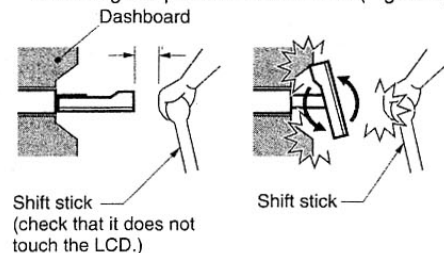

Figure 2

- Install the unit within 30° of the horizontal plane. (Figure 3)

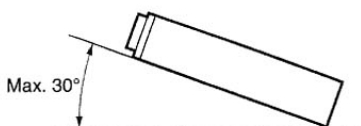

Figure 3

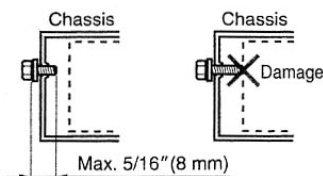

Figure 4

- The source unit has mounting screw holes for NISSAN (N marks) and TOYOTA (T marks) vehicles, and for Clarion installation kit (C marks).

When you use a mounting kit sold separately, affix the screws to the ● marks above according to the type of the vehicle. (Figure 5)

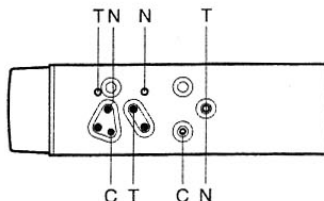

Figure 5

4. INSTALLING THE SOURCE UNIT

■ Universal Mount

1. Place the universal mounting bracket into the instrument panel, use a screwdriver to bend each stopper of the universal mounting bracket inward, then secure the stopper as shown in Figure 6.
2. Wire as shown in Section 7.
3. Insert the source unit into the universal mounting bracket until it locks.
4. Mount the outer escutcheon so that all the hooks are locked.

Notes:

- 1) Some car models require special mounting kits for proper installation. Consult your Clarion dealer for details.
- 2) Fasten the front stopper securely to prevent the source unit from coming loose.

• Console opening dimensions

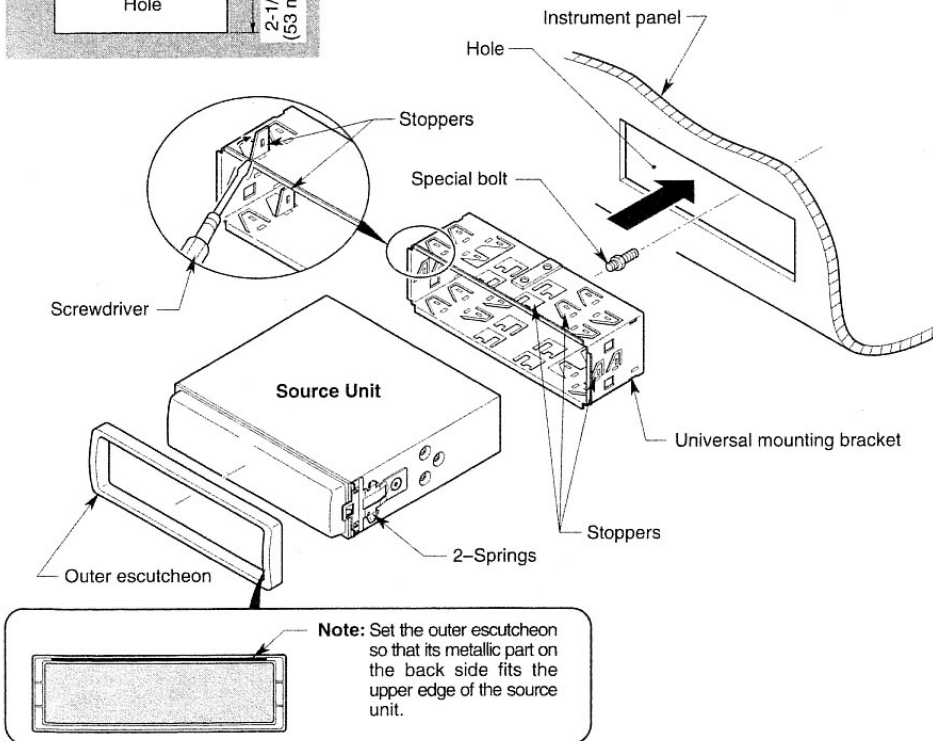
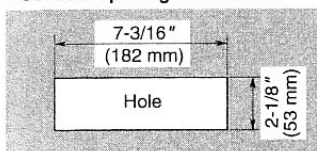

Figure 6

■ Fixed Mount (TOYOTA, NISSAN and other ISO/DIN equipped vehicles)

This unit is designed for fixed installation in the dashboard.

If the vehicle is equipped with a factory-installed radio, install the source unit with the parts and screws marked (*) (Figure 8).

If the vehicle is not equipped with a factory-installed radio, obtain an installation kit to install the source unit in the following procedure.

1. Remove the screws at both sides of the source unit and slide the springs to the direction of arrow and remove them (Figure 7).

2. Secure the mounting brackets to the chassis as shown in Figure 8. Holes are pre-tapped for TOYOTA and NISSAN vehicles; modification, such as drilling new holes, of the mounting brackets may be required for other models.

3. Wire as shown in Section 7.

4. Secure the unit in the dashboard, and then reassemble the dashboard and the center panel.

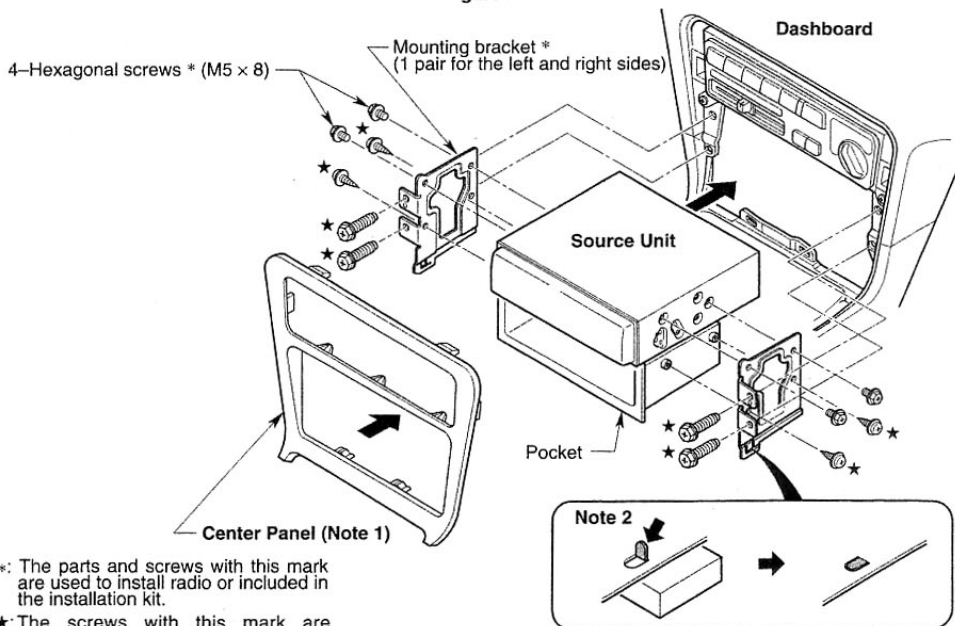
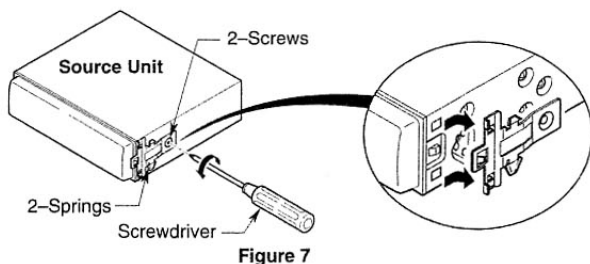

Note 1: In some cases, the center panel may require some modification (trimming, filling, etc.).

Note 2: If a hook on the installation bracket interferes with the unit, bend and flatten it with a nipper or a similar tool.

■ Installing the Tuner Amplifier Unit

Before installing the tuner amplifier unit, position it considering safety and operability of the entire system. (Figure 9)

Sample installation (when the unit is installed under the front seats)

Install the unit under the front seats using the included parts. If there are not enough space under the seats, consult the store where you purchased the unit.

1. Attach the mounting brackets on the left and right side of the tuner amplifier unit using the attached screws (M4 × 8). (Figure 9)
2. Position the tuner amplifier unit on the floor carpet and drill holes through the carpet at the position where the holes of the bracket fit.
3. Push the attached plastic blind clips through the holes on the carpet into the mounting bracket holes.

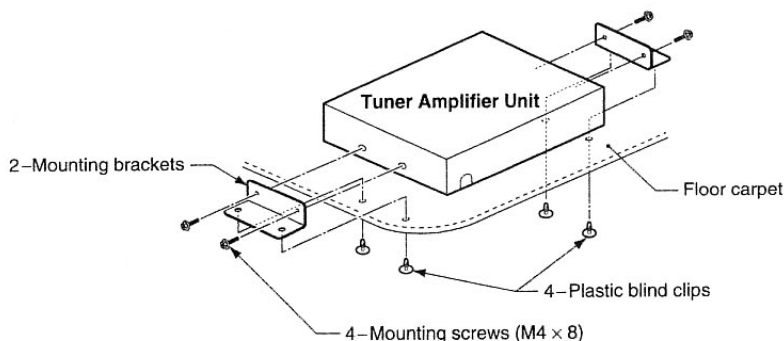

Figure 9

5. REMOVING THE SOURCE UNIT

1. When the back of the source unit has been secured with the method shown in Figure 6 unfasten the special bolt.
2. Remove the outer escutcheon.
3. Insert the hook plate between the spring and the universal mounting bracket, fit tab (B) of the spring into hole (A) of the hook plate, then

pull the source unit out by the hook plate. (Insert both the right and left edges of the hook plate.) (Figure 10)

Note: Keep the hook plate. You cannot remove the unit without disengaging the hook plate.

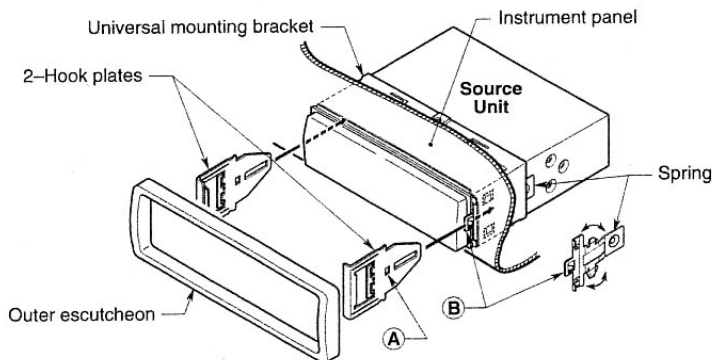

Figure 10

6. CAUTIONS ON WIRING

1. Be sure to turn the power off before wiring.
2. Be particularly careful where you route the wires.
Keep them well away from the engine, and exhaust pipe, etc. Heat may damage the wires.
3. If the fuse should blow, check to see if the wiring is correct.
If it is, replace the fuse with a new one with the same amperage rating as the original.
4. To replace the fuse, release the catch on the source unit side, remove the old fuse and insert the new one. (Figure 11)

Note: There are various types of fuse holder. Do not let the battery side and touch other metal parts.

Example 1: Amplifier control (Blue/white)

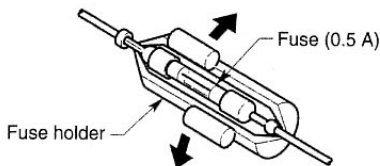

Example 2: Main power supply (Yellow)

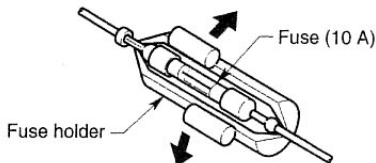
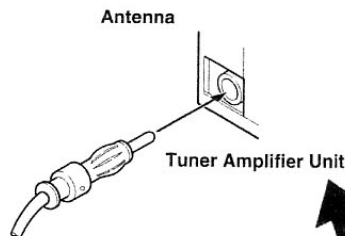

Figure 11



5. When connecting the ground lead, fasten the ground lead (black) securely to a clean metal plate on the car. (Figure 12)

If the set is insufficiently grounded, it may not operate or there may be noise.

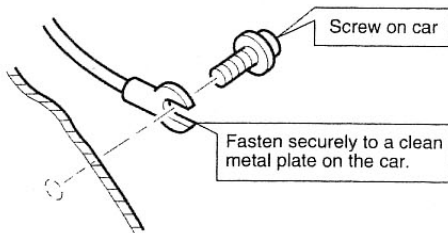

Figure 12



After the connection, fix the lead by a clamp or insulation tape for protection.

⚠ WARNING

This product must be installed and used only in accordance with these instructions. DO NOT CONNECT A TELEVISION TUNER TO THIS PRODUCT OR OTHERWISE ALTER THIS PRODUCT SO THAT IT CAN BE USED FOR RECEIVING TELEVISION BROADCAST SIGNALS OR FOR PLAYING VIDEO TAPES OR VIDEO GAMES. Any alteration of this product that enables it to be used in ways other than those provided for in this manual could distract the driver and result in an accident for which the installer may be held liable. CLARION DISCLAIMS ANY LIABILITY THAT MAY RESULT FROM A FAILURE TO INSTALL AS INDICATED IN THESE INSTRUCTIONS.

7. WIRE CONNECTIONS

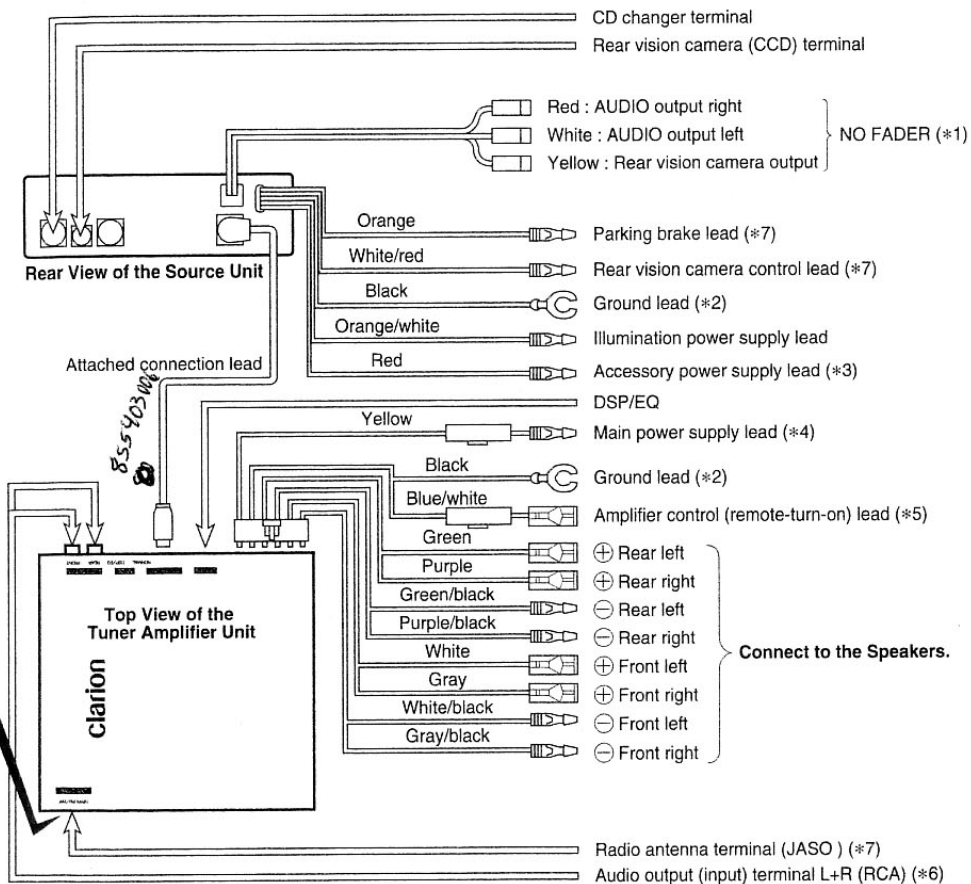

- *1: Fader cannot be adjusted with these outputs. Connect them to an amplifier (sold separately), etc.
- *2: Connect securely to the metal part of the vehicle with a screw, etc.
- *3: Connect to the power supply terminal which can be turned on and off by the ignition switch.
- *4: Connect to the power supply terminal where the power is always supplied regardless of whether the ignition switch is turned on or off.
- *5: Connect to the remote turn-on lead of amplifiers.
- *6: Connect to an external amplifier or Clarion expand DSP/EQ (sold separately), etc. using the RCA lead (L, R) (sold separately).
- *7: Use the attached extension lead when necessary.

■ Connecting the Accessories

• Connection to the external amplifier

The external amplifier can be connected to the audio output terminal (RCA terminal) (red, white) on the side of the tuner amplifier unit and the source unit.

• Connection to the rear vision camera for vehicle

The rear vision camera for vehicle can be connected to the rear vision camera (CCD) terminal on the source unit.

For details, refer to the instruction sheet or manual for the rear vision camera.

Note: A power supply box (sold separately) is required for connection of the source unit and the rear vision camera.

• Connection to the DSP or equalizer

The Clarion DSP or equalizer, DPH9100 or EQH5100, (sold separately) can be connected to the connection terminal for the tuner amplifier unit and the audio terminal (RCA terminal) (red, white).

For details, refer to the instruction manual for the DSP or equalizer.

Note: When connecting the DSP or equalizer, the switch (Normal/DSP equalizer) on the attached tuner amplifier unit should be set to "D".

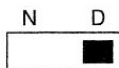

8. SAMPLE SYSTEMS

■ Sample System 1

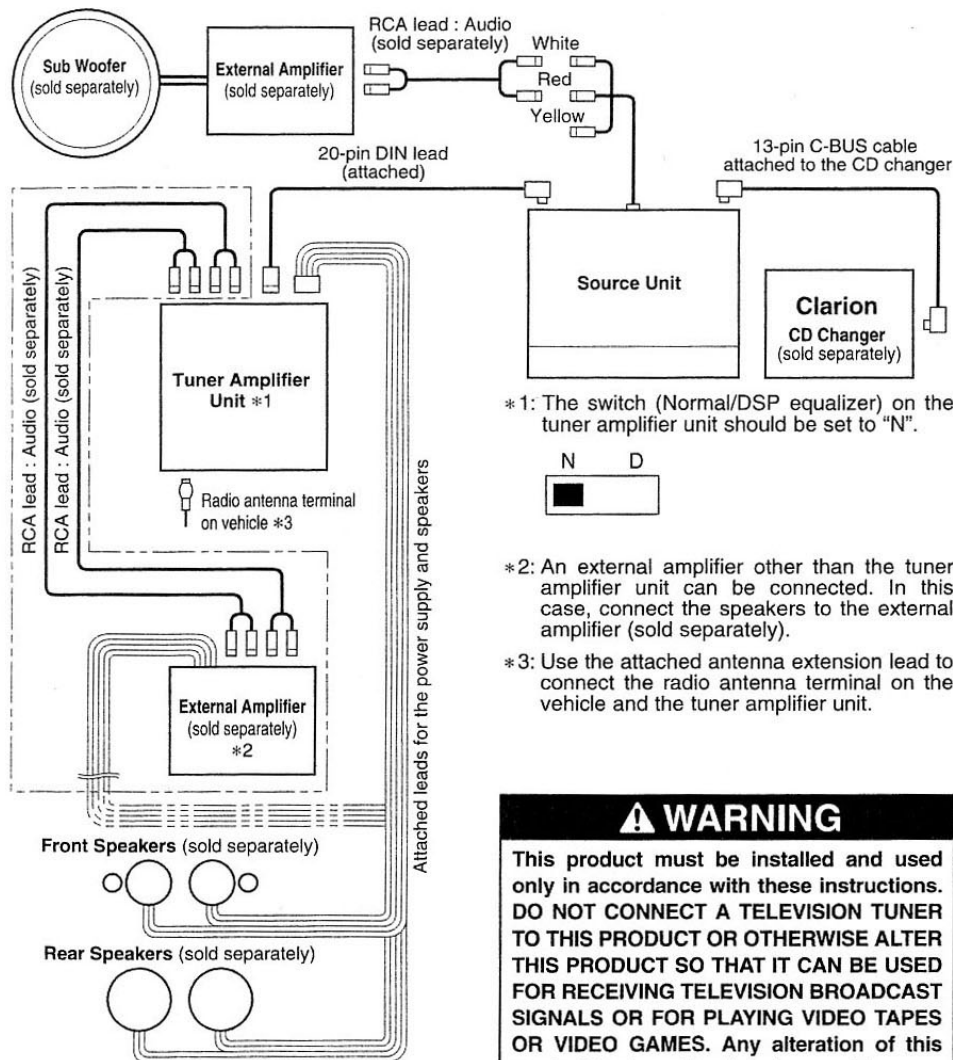

⚠ WARNING

This product must be installed and used only in accordance with these instructions. DO NOT CONNECT A TELEVISION TUNER TO THIS PRODUCT OR OTHERWISE ALTER THIS PRODUCT SO THAT IT CAN BE USED FOR RECEIVING TELEVISION BROADCAST SIGNALS OR FOR PLAYING VIDEO TAPES OR VIDEO GAMES. Any alteration of this product that enables it to be used in ways other than those provided for in this manual could distract the driver and result in an accident for which the installer may be held liable. CLARION DISCLAIMS ANY LIABILITY THAT MAY RESULT FROM A FAILURE TO INSTALL AS INDICATED IN THESE INSTRUCTIONS.

■ Sample System 2 (DSP or Equalizer is connected)

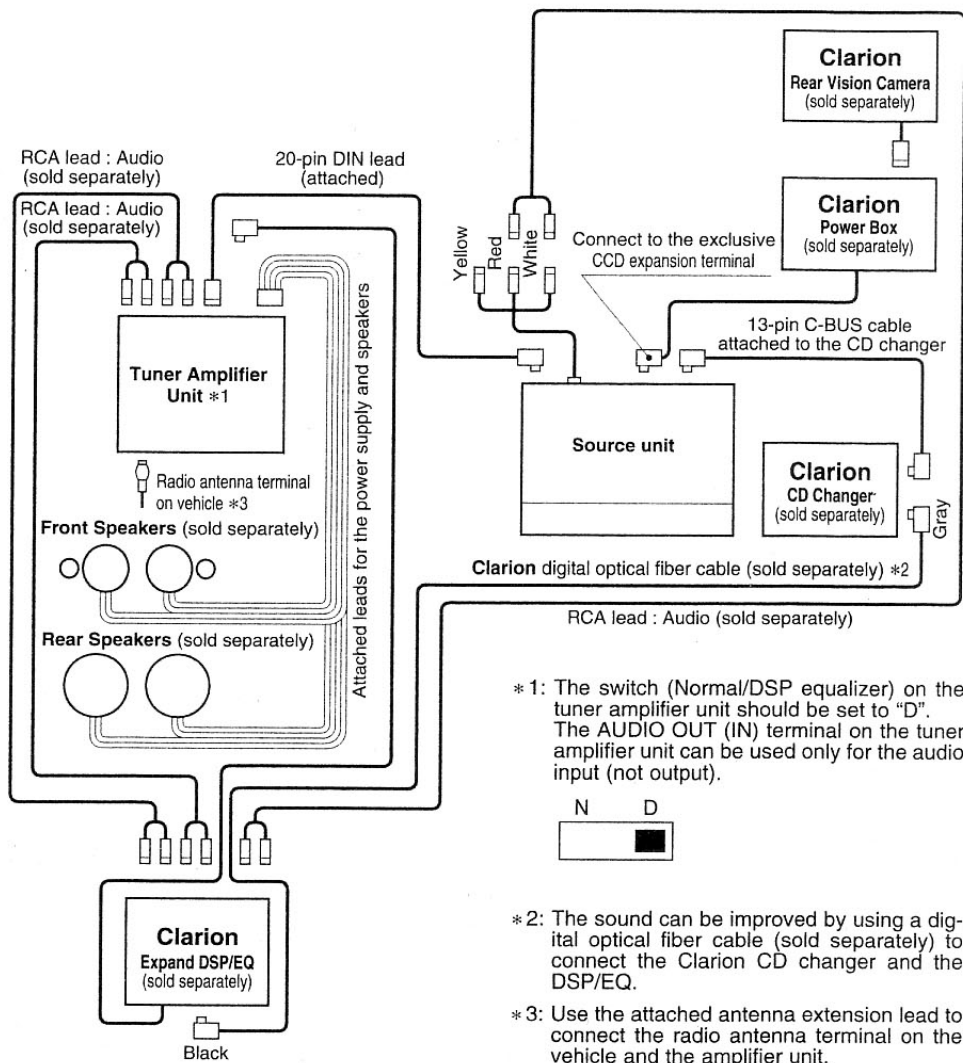

9. GENERAL CAUTIONS

1. Do not open the case. There are no user serviceable parts inside. If you drop anything into the unit during installation, consult your dealer or an authorized CLARION service center.
2. Use a soft, dry cloth to clean the case. Never use a rough cloth, thinner, benzene, or alcohol, etc. For tough dirt, apply a little cold or warm water to a soft cloth and wipe off the dirt gently.